

SAMSUNG

MICRO COMPONENT
DVD AUDIO SYSTEM
DVD/CD-R/RW/MP3-CD PLAYBACK
MM-DB9



Instruction Manual



Safety Warnings

GB

CLASS 1 LASER PRODUCT
KLASSE 1 LASER PRODUKT
LUOKAN 1 LASER LAITE
KLASS 1 LASER APPARAT
PRODUCTO LASER CLASE 1

	CAUTION RISK OF ELECTRIC SHOCK. DO NOT OPEN	
<p>CAUTION: TO REDUCE THE RISK OF ELECTRIC SHOCK, DO NOT REMOVE REAR COVER. NO USER SERVICEABLE PARTS INSIDE. REFER SERVICING TO QUALIFIED SERVICE PERSONNEL.</p>		

CLASS 1 LASER PRODUCT

This Compact Disc player is classified
as a CLASS 1 LASER product.

Use of controls, adjustments or performance of procedures other than those specified herein may result in hazardous radiation exposure.

**CAUTION-INVISIBLE LASER RADIATION WHEN OPEN
AND INTERLOCKS DEFEATED, AVOID EXPO-
SURE TO BEAM.**



This symbol indicates that dangerous voltage which can cause electric shock is present inside this unit.



This symbol alerts you to important operating and maintenance instructions accompanying the unit.

WARNING: To reduce the risk of fire or electric shock, do not expose this appliance to rain or moisture.

CAUTION: TO PREVENT ELECTRIC SHOCK, MATCH
WIDE BLADE OF PLUG TO WIDE SLOT, FULLY
INSERT.

Contents

Thank you for buying this
SAMSUNG micro component system.

Please take time to read these instructions.
They will allow you to operate your
system with ease and take full advantage
of its features.



◆ SAFETY WARNINGS	2	■ Setting up the Language Features	22
◆ INSTALLING YOUR MICRO COMPONENT SYSTEM		◆ TUNER	
■ Front Panel View	4	■ Searching for and Storing the Radio Stations.....	23
■ Rear Panel View	5	■ Selecting a Stored Station.....	23
■ Remote Control	6	■ Improving Radio Reception	23
■ Where to Install Your Micro Component System.....	8	◆ TAPE DECK	
■ Connecting your System to the Power Supply	8	■ Listening to a Cassette	24
■ Connecting to an External Source	8	■ Tape Counter	24
■ CD Digital Out Jack	8	■ Selecting the Cassette Playback Mode	24
■ Speaker Connection.....	9	■ Recording a Compact Disc	25
■ Connecting the AM (MW)/LW Aerial	10	■ Recording a Radio Program	25
■ Connecting the FM Aerial	10	◆ OTHER FUNCTIONS	
■ Connecting the SW Aerial(option).....	11	■ Timer Function	26
■ Connection of the TV monitor	11	■ Cancelling the Timer	26
■ Connection for better sound	12	■ Mute Function	27
■ 7-Color Display Function.....	13	■ Selecting an Equalizer Preset.....	27
■ Demo Function	13	■ S. Bass Function	27
■ Setting the Clock.....	13	■ Power Surround	27
◆ DVD/CD-PLAYER		■ Setting the System to Switch off Automatically.....	28
■ Playing a Disc.....	14	■ Connecting Headphones.....	28
■ DVD Playback.....	14	■ Microphone	28
■ Forward/Reverse Searching.....	15	◆ RECOMMENDATIONS FOR USE	
■ Slow Playback/Checking the Remaining Time	16	■ Safety Precautions	29
■ Repeat Playback.....	16	■ Cleaning Your Micro Component System.....	29
■ Using Disc Menu/Title	17	■ Precautions When Using Compact Discs	30
■ Program Playback	17	■ Precautions When Using Audio Cassettes	30
■ Selecting the Audio Language/Subtitle Language	18	■ Before Contacting the After-Sales Service	30
■ Various DVD Functions	19	■ Technical Specifications	31
■ MP3 Playback.....	20	■ Reference	32
■ System Setup	21		

Symbols



Press



Push



Important



Note

Front Panel View

GB

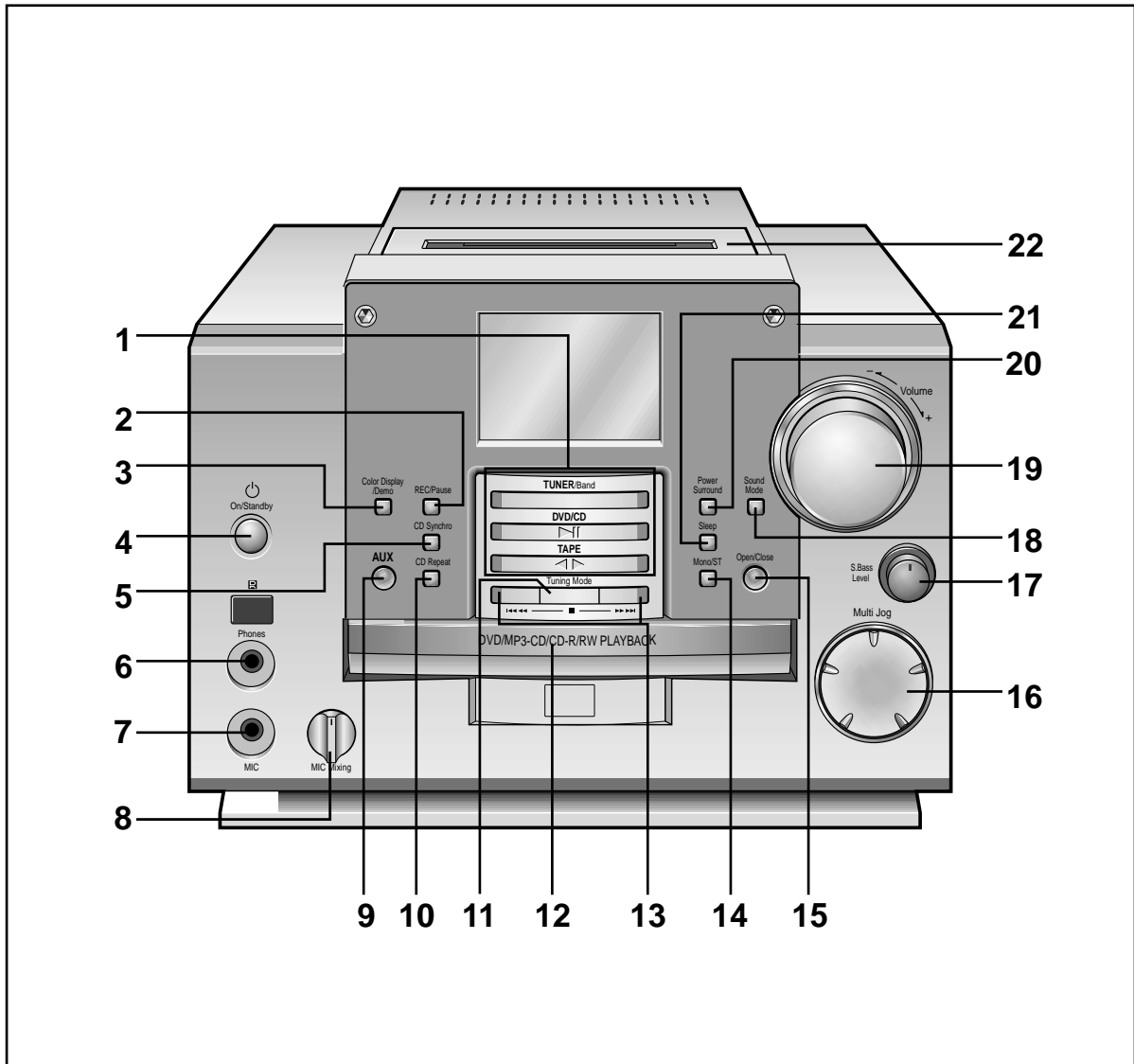

- | | |
|-----------------------------------|---|
| 1. Function (TUNER, DVD/CD, TAPE) | 12. Disc Tray |
| 2. REC/Pause | 13. Skip or Search |
| 3. Color Display/Demo | 14. FM Mono/ST. |
| 4. On/Standby | 15. CD Door open/close |
| 5. CD Synchro | 16. Multi Jog |
| 6. Headphone Jack Connector | 17. S.Bass Level |
| 7. MIC(option) | 18. Sound Mode |
| 8. MIC Mixing(option) | 19. Volume |
| 9. AUX | 20. Power Surround |
| 10. CD Repeat | 21. Sleep |
| 11. Stop | 22. Push Eject (Cassette Door Open/Close) |

Rear Panel View

GB

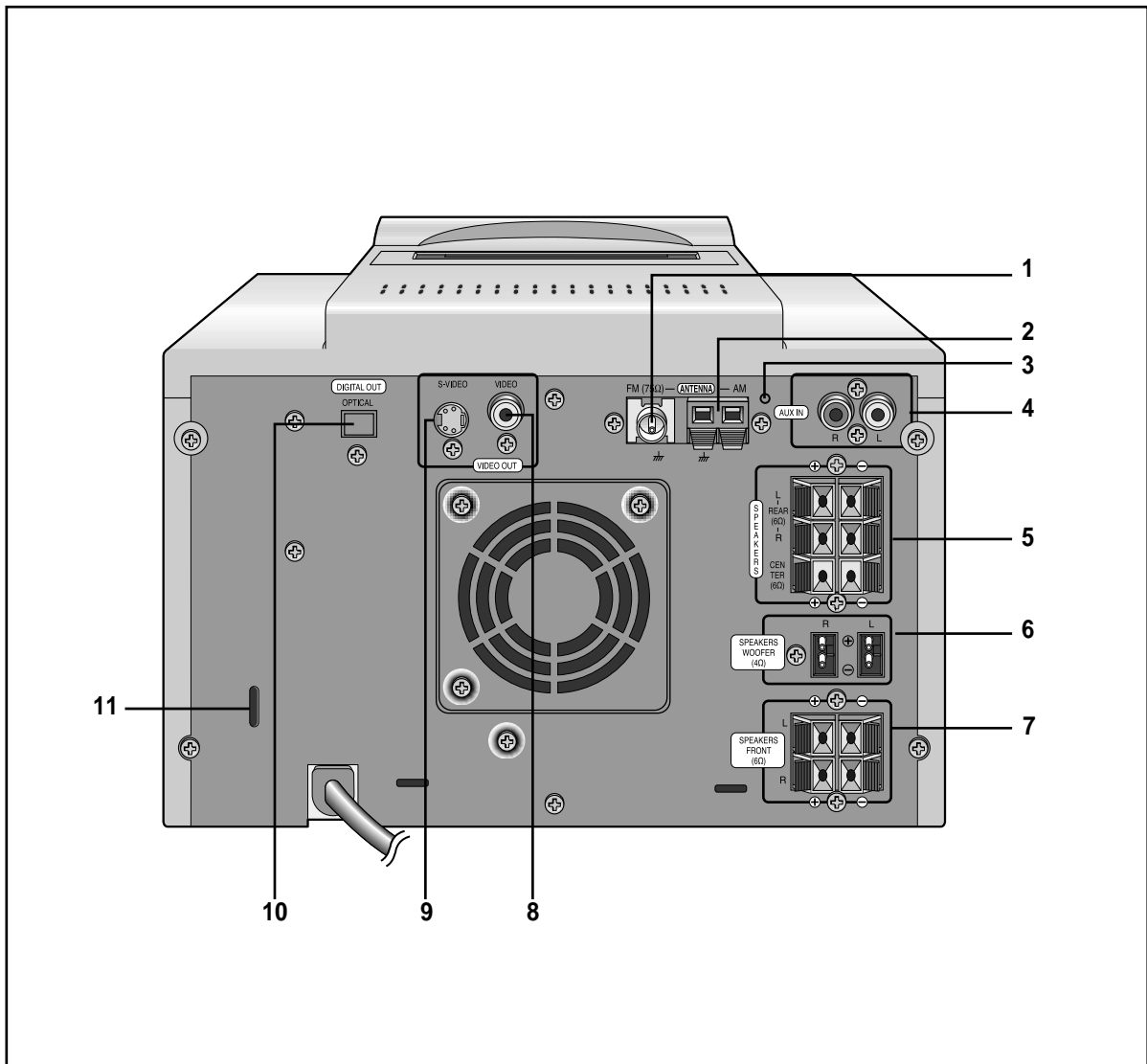

1. FM Aerial Connector Terminal
2. AM Aerial Connector Terminal
3. SW Aerial Connector Terminal(option)
4. AUX-Input
5. REAR Speaker / CENTER Speaker
6. SUBWOOFER Speaker
7. FRONT Speaker
8. VIDEO OUT
9. S-VIDEO OUT
10. CD Digital Out jack
11. Voltage Selector(option)



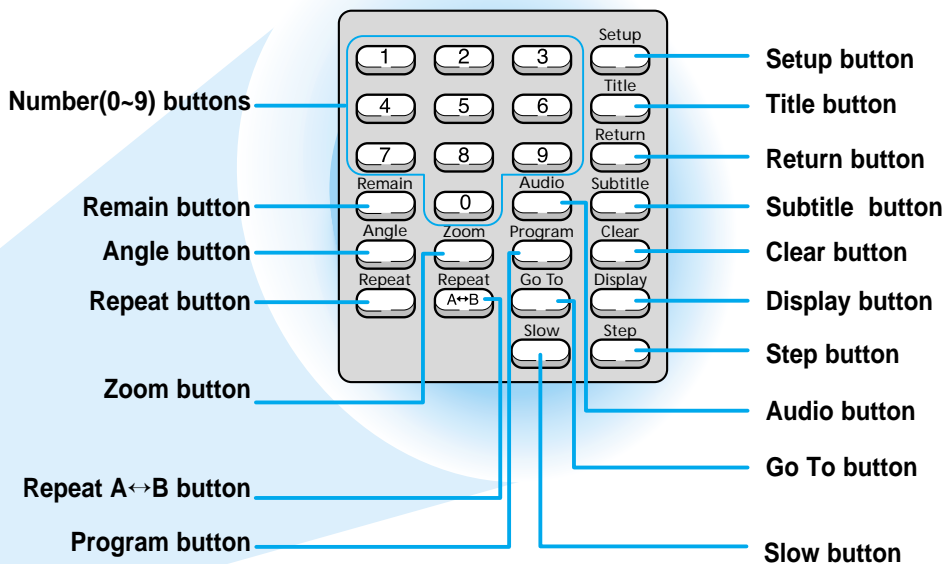

Insert Remote Batteries

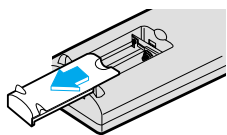

1 Remove the battery cover on the back of the remote by pressing down and sliding the cover in the direction of the arrow.

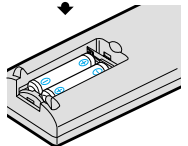

2 Insert two 1.5V AAA batteries, paying attention to the correct polarities (+ and -).

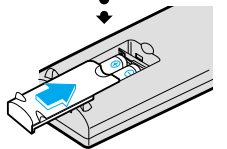

3 Replace the battery cover.



Follow these precautions to avoid leaking or cracking cells:

- Place batteries in the remote control so they match the polarity:(+) to (+)and (-)to (-).
- Use the correct type of batteries.Batteries that look similar may differ in voltage.
- Always replace both batteries at the same time.
- Do not expose batteries to heat or flame.

Video Output Selection

◆ Press the **REC/Pause** button in **POWER OFF**, then it is converted to

“ NTSC PAL ” and select the TYPE you want.

Example : Select **PAL**, if TV is for **PAL**.

When disk is set to NTSC in PAL, it doesn't operate.

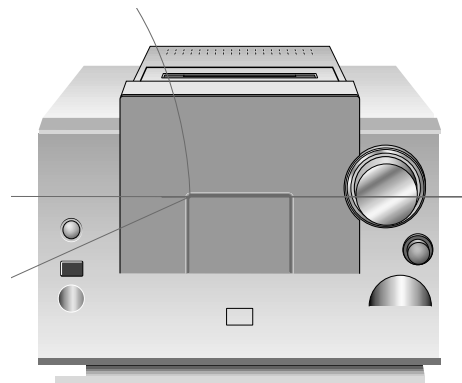

Where to Install Your Micro Component System

GB

To take full advantage of your new micro component system, follow these installation instructions before connecting the unit.

- ◆ Install the system on a flat, stable surface.
- ◆ Never place this unit on carpeting.
- ◆ Never place this unit in an outdoor area.
- ◆ Maintain an open space of approximately 6 inches (15 cm) on the sides and rear of the system, for ventilation purposes.
- ◆ Make sure that you have enough room to open the compact disc compartment easily.
- ◆ Place the loudspeakers at a reasonable distance on either side of the system to ensure good stereo sound.
- ◆ Direct the loudspeakers towards the listening area.
- ◆ For optimum performance, make sure that both speakers are placed at an equal distance above the floor.

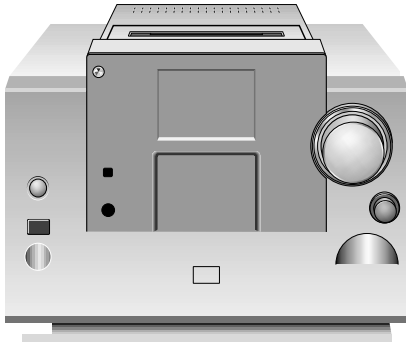

Connecting your System to the Power Supply

The main lead must be plugged into an appropriate socket.

- 🔌 Before plugging your system into a main socket, you must check the voltage.

- 1 Check the position of the voltage selector on the rear of the system (OPTIONAL).
- 2 Plug the main lead (marked **AC Cord** on the rear of the system) into an appropriate socket.
- 3 Press the **Standby/On**  button to switch your mini-compact system on.

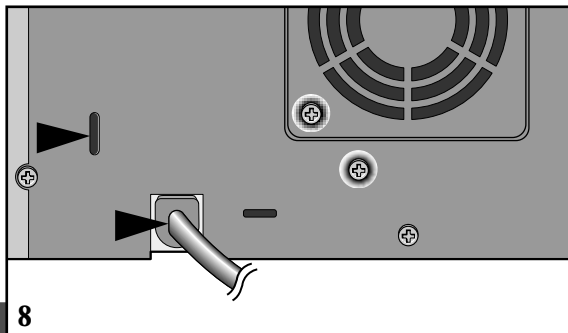

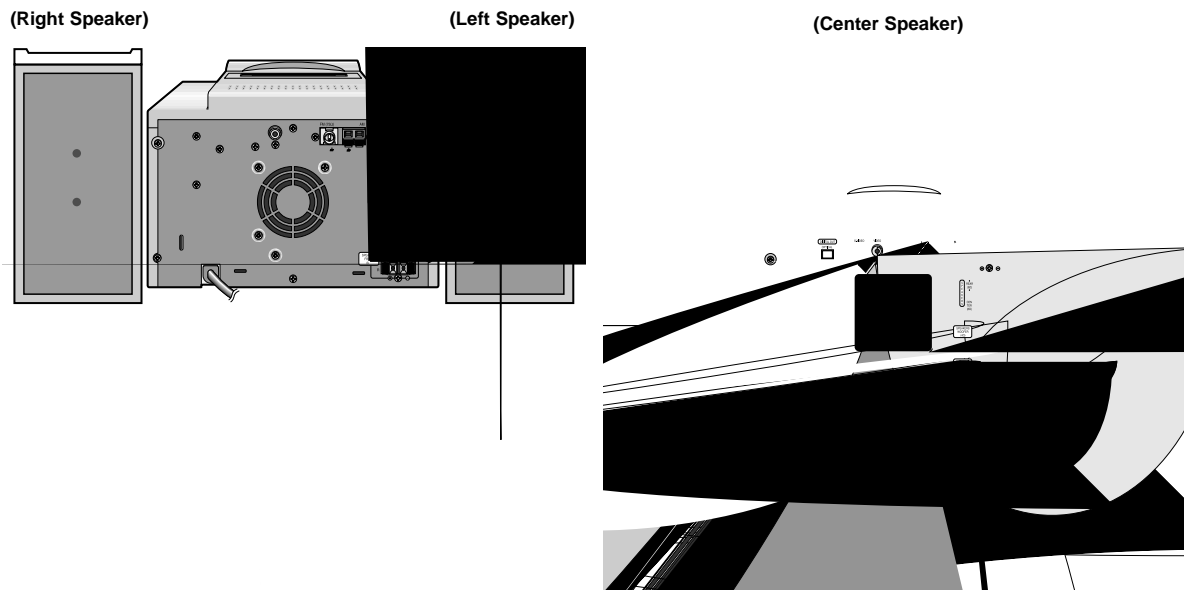

Directions in Installing Speaker

- ◆ Installation in a place near heating apparatus, under direct lay of light or with high humidity may cause performance degradation of the speaker.
 - ◆ Do not install on the wall or on a high place of pole or other unstable place to prevent any safety accident caused by falling of the speaker.
 - ◆ Do not take the speaker apart from TV or computer monitor. The speaker near the TV or computer monitor may influence the quality of the screen display.
- ◆ When playing back a 5.1 channel encoded DVD, sound is output from the center and rear speakers only.
- ◆ When playing back a 2 channel encoded DVD, CD, tape, or tuner, no sound is output from the center and rear speakers.

Connecting the AM (MW)/LW Aerial

GB

The AM aerial (for long and medium waves) can be:

- ◆ Placed on a stable surface
- ◆ Fixed to the wall (you must first remove the base)

The **AM** aerial connector terminals are located on the rear of the system and are marked **AM**.

- ☛ To avoid noise interference, check that the loudspeaker wires do not run close to the aerial wires. Always keep them at least 2 inches (5 cm) away.

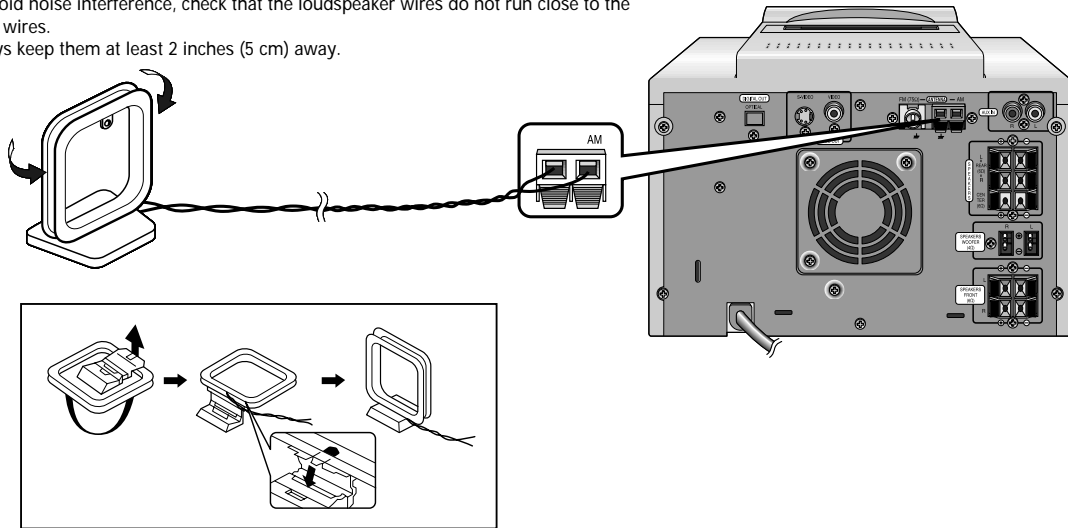

Connecting the FM Aerial

How to connect a COAXIAL TYPE aerial.

- ◆ Connect a 75Ω antenna to the **FM** antenna terminal.
- ◆ Plug the connector on the **FM** aerial supplied into the coaxial socket (75Ω) marked **FM** on the rear of the system.
- ◆ Follow the instructions given on Page 23 to tune into a radio station, and determine the best position for the aerial.
- ◆ If reception is poor, you may need to install an outdoor aerial. To do so, connect an outdoor **FM** aerial to the **FM** socket on the rear of the system using a 75Ω coaxial cable (not supplied).

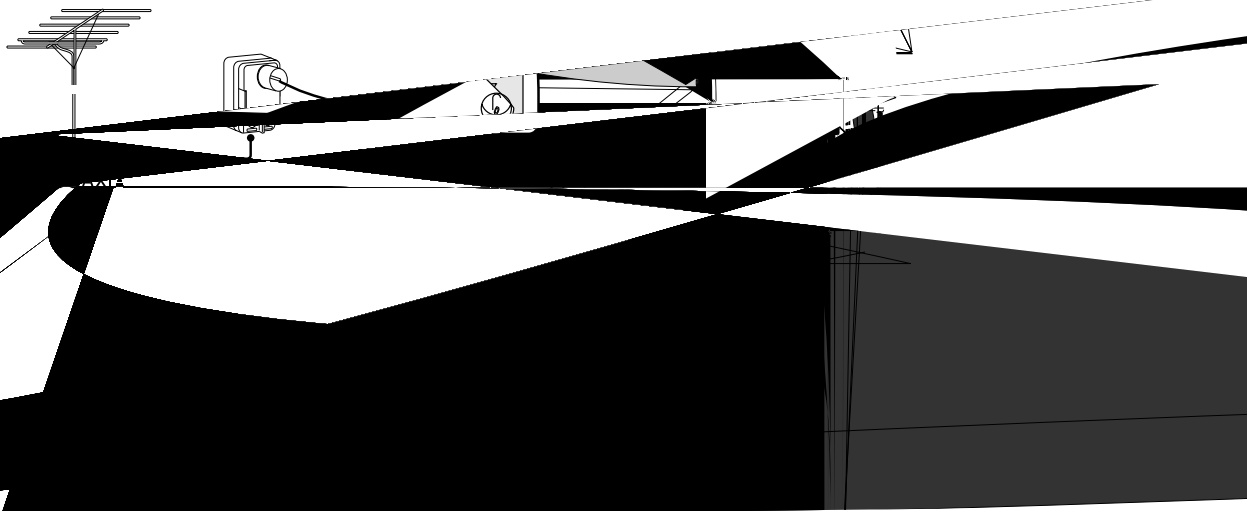
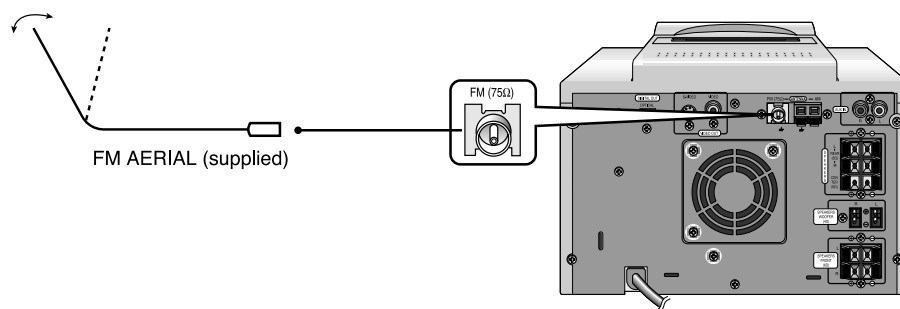

Connection of the TV monitor

The following show examples of connections commonly used to connect the DVD player with a External Source.

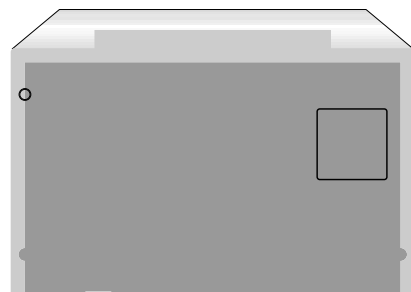

- When S-VIDEO is connected, S-VIDEO has priority.

Connection for better sound

Connecting to an amplifier with Dolby Pro Logic support.

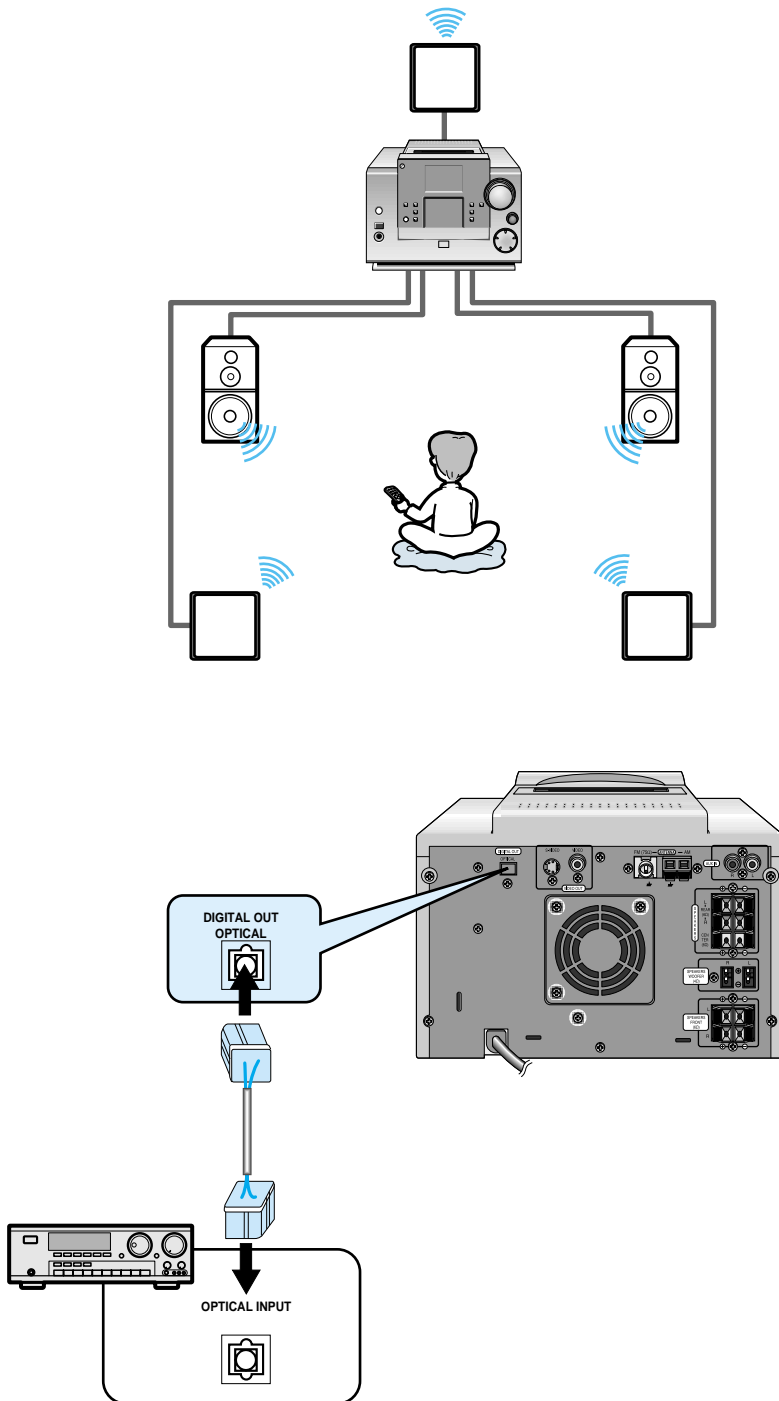

7-Color Display Function

The System allows you to choose your favorite color to produce your own personal atmosphere.

- 1 Switch the system on by pressing **On/Standby** (⏻/⏻).
- 2 Press the **Color Display/Demo** button and select the color you want.
Result: Whenever the button is pressed, the color is repeated in the sequence of Cyan → Green → Red → Blue → Violet → Y. Green → White → Off → Auto.
- 3 If you select Auto mode, 7 colors are displayed for 3 seconds alternatively.



Demo Function

You can view the various functions available on your system.

- 1 Switch the system off by pressing **On/Standby** (⏻/⏻).
 - 2 Press the **Color Display/Demo** button.
Result: The various functions available are listed in turn on the display.
- All these functions are described in detail in this booklet. For instructions on how to use them, refer to the appropriate sections.
- 3 To cancel this function, press **Color Display/Demo** again.

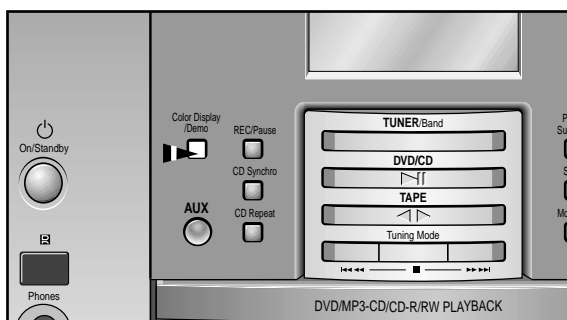

Setting the Clock



Your system is equipped with a clock which allows you to turn your system on and off automatically. You should set the clock:

- ◆ When you first purchase the micro component system
 - ◆ After a power failure
 - ◆ After unplugging the unit
- ◆ For each step, you have a few seconds to set the required options. If you exceed this time, you must start again.

- 1 Switch the system on by pressing **On/Standby** (⏻/⏻).
- 2 Press **Timer/Clock** twice.
Result: **CLOCK** is displayed.
- 3 Press **Enter**.
Result: The hour flashes.
- 4

To...	Press...
Increase the hours	▶
Decrease the hours	◀
- 5 When the correct hour is displayed, press **Enter**.
Result: The minutes flash.
- 6

To...	Press...
Increase the minutes	▶
Decrease the minutes	◀
- 7 When the correct time is displayed, press **Enter**.
Result: The clock starts and is displayed, even when the system is in standby mode.

- ◆ You can display the time, even when you are using another function, by pressing **Timer/Clock** once.
- ◆ You can use the **Multi Jog** to instead ◀/▶ button in step 4,6.



Playing a Disc

GB

Playback

- 1 Press the **Open/Close** (▲) button.
- 2 Place a disc gently into the tray with the disc's label facing up.
- 3 Press the **Play/Pause** (▶||) button or **Open/Close** (▲) button to close the disc tray.

◆ When playing back MP3-CD's, song titles are not displayed on the main unit, but on the TV screen.

Pausing Playback

Press the **Play/Pause** (▶||) button during playback.

◆ To resume, press the **Play/Pause** (▶||) button again.

- Depending on the disc, the initial disc information screen may look disc to disc.
- ◆ When playing a DVD containing MPEG format, video may not be reproduced correctly and you may get picture distortion.

Stopping Playback

Press the **Stop** (■) button during playback.

◆ During playback, when the **Stop** (■) button is pressed, the position is stored in the memory, and **STOP** is shown on the display.

When the **Play/Pause** (▶||) button or **Return** button is pressed subsequently, playback resumes from the position at which it was stopped.

◆ If the **Stop** (■) button is pressed a second time, the resume play' memory function is canceled, and **STOP** is shown on the display. When the **Play/Pause** (▶||) button is pressed, playback starts from the beginning.

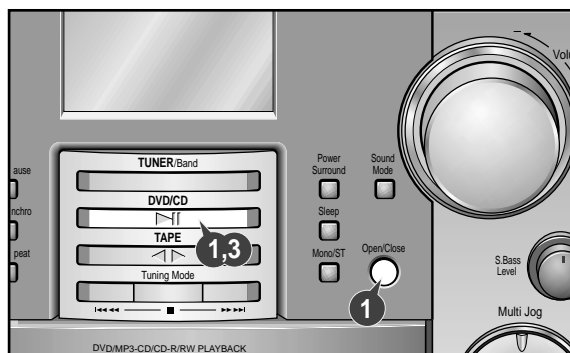

DVD Playback

Using the On-Screen Display

Press the **Display** button on the remote.

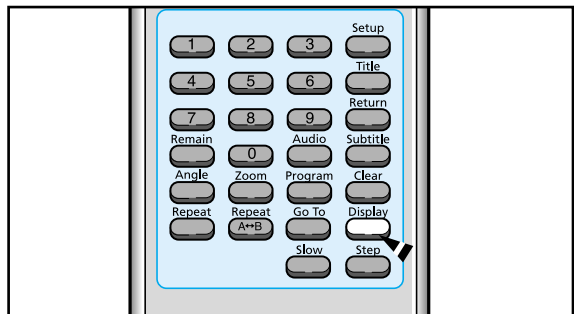
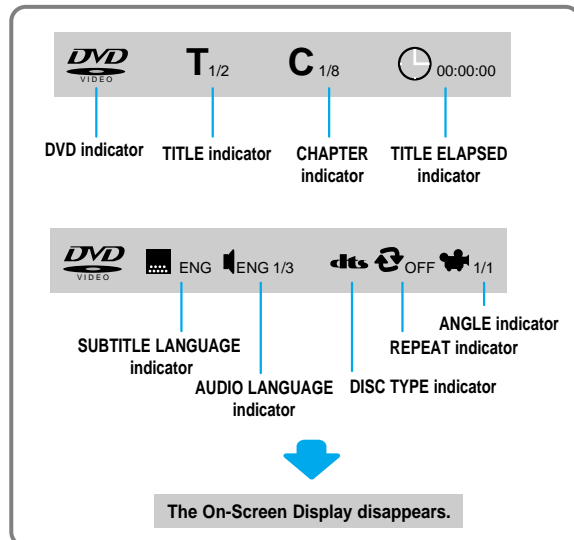

What is a Title?

◆ A movie contained in a DVD disc.

What is a Chapter?

◆ Each Title on a DVD disc is divided into several smaller sections called "chapters".

Turning the sound off temporarily?

Press the **Mute** button during playback.

◆ This operation may be useful when you need to greet the guests or answer the telephone.

➤ ◆ If the player is left for more than 3 minutes in pause mode, it will stop.

Forward/Reverse Searching

During playback, you can search quickly through a chapter or track for a specific scene or tune.

High-Speed Playback

Press the ◀◀ and ▶▶ button.

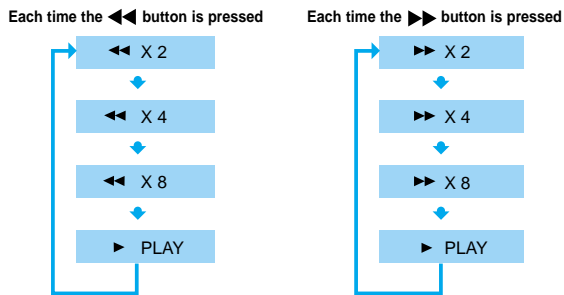

◆ ◀◀ playback (reverse playback) is possible on DVDs.

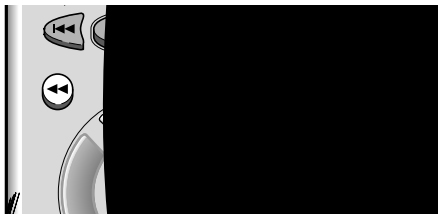

Skipping through a Chapter

Press the ◀◀ and ▶▶ button.

- ◆ Each time the button is pressed during playback, it moves to the next or previous chapter and plays it.
- ◆ However, you cannot skip forward or backward through consecutive chapters.

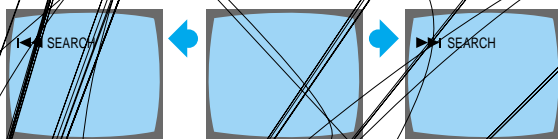

Playing Frame by Frame

Press the ◀ button.
The video moves forward one frame each time the button is pressed.
No sound is heard during high-speed playback and step motion.

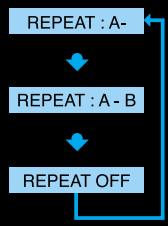

To return to normal playback



Using Disc Menu/Title

To Select the Disc Menu

You can use the menus for the audio language, subtitle language, profile, etc. DVD menu contents differ from disc to disc.

- 1 Press the **Menu** button during playback.
 - ◆ The Menu Screen appears.
 - ◆ When playing a VCD version 2.0, you can operate it using PBC On/Off function.
- 2 Use the **Up/Down** (▲/▼) or **Left/Right** (◀/▶) button to access the different features.
- 3 Press the **Enter** button.
 - ◆ The selected item will play.

Using the Title Menu

Press the **Title** button.

- ◆ For DVDs containing multiple titles, you can view the title of each movie.
- ◆ Depending on the disc, this function may either not work at all, or may work differently.





Various DVD

● To enlarge an

Press the **Zoom** button.

- ◆ Images can be enlarged 2
- ◆ During DVD playback, pre
- ◆ Press (◀/▶/▲/▼) to

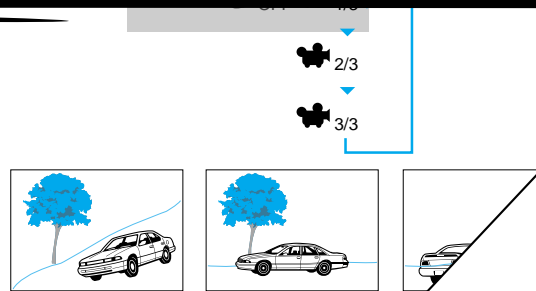
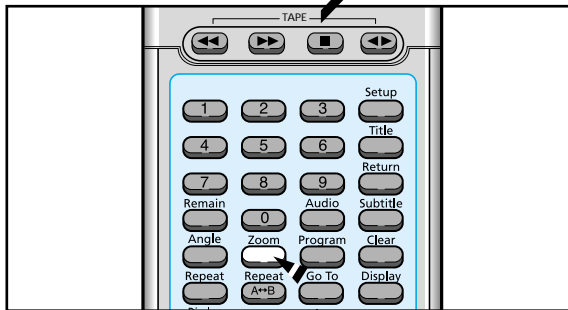

MP3 Playback

GB

This system is incorporated with an MP3 decoder. You can play back MP3 tracks (files) recorded on CD-Rs, CD-RWs, and CD-ROMs.

Starting Playback

◆ It is recommended to turn on your TV when playing back an MP3 disc.

- 1 Press the **Open/Close** (▲) button to load a disc.
- 2 Press the **Play/Pause** (▶||) button.
 - ◆ After detecting the disc, playback starts.
 - ◆ The on-screen bar and the contents recorded on the MP3 disc will be shown on the TV if it is turned on.

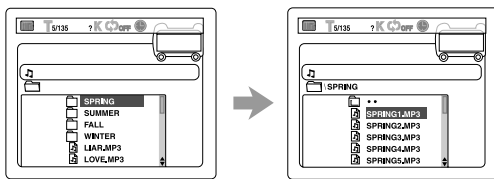

What is MP3?

MP3 is an abbreviation of Motion Picture Experts Group (or MPEG) Audio Layer 3. MP3 is simply a file format with a data compression ratio of 1:10 (128 Kbps*).

That means, by using MP3 format, one CD-R or CD-RW can contain 10 times as much data volume as a regular CD can.

*Bit rate is the average number of bits that one second of audio data will consume. The measuring unit used is Kbps (1000 bits per second).

To get a better audio quality, choose a higher bit rate. The most popular bit rate for encoding (recording) is 128 Kbps.

To stop during playback

Press the **Stop** (■) button.

System Setup

You can use the DVD player's Setup function to select the TV screen ratio, rating limit, or digital output mode.

To Set up the System

- 1 From the stop mode, press the **Setup** button.



- 2 Press the **Left/Right** (◀/▶) button to select the system.

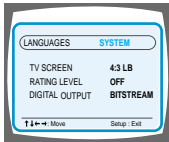

- 3 Press the **Up/Down** (▲/▼) button to select the desired item.

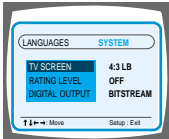

- 4 Press the **Enter** button or **Right** (▶) button.
 - ◆ Move to the detailed items.
 - ◆ Then press the **Left** (◀) button to return to the previous step.

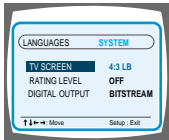

- 5 Press the **Up/Down** (▲/▼) button to select the desired sub-item and then press the **Enter** button.

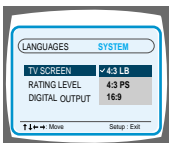

To End the System Setup

- ◆ Press the **Setup** button again.

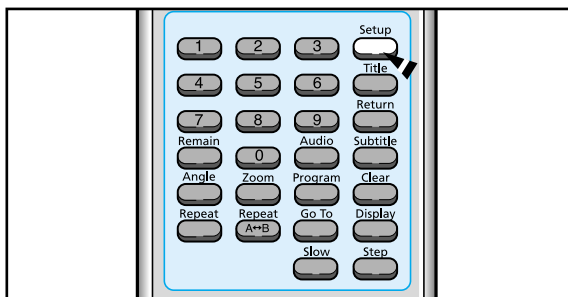

TV SCREEN(TV SCREEN RATIO)

Select when you want to watch a 16:9 screen ratio DVD movie on a TV with a 4:3 ratio screen.

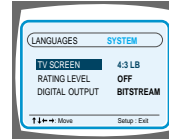

- 4:3LB** ◆ You can see the full 16:9 picture, but black bars will appear at the top and bottom of the screen.
- 4:3PS** ◆ You can only view the central portion of the 16:9 screen.
- 16:9** ◆ You can view in wide screen but the top and bottom of the picture will be cut off.

- ◆ However if the movie is recorded in 4:3 ratio, you cannot view the full 16:9 picture with the above functions.

RATING LEVEL

The Rating Level function works in conjunction with DVDs which have been assigned a rating, to help control the type of DVD that your family watches.

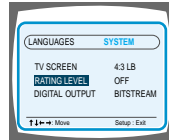

- 1 Select **RATING LEVEL**, then press the **Enter** button.

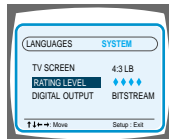

- 2 Use the number(0-9) buttons to input a 4-digit password.
 - ◆ The player's password is set to "7890" by default.

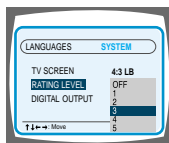

- 3 Use the **Up/Down** (▲/▼) button to select either **RATING LEVEL** or **NEW PASSWORD**, and then press the **Enter** button.
 - ◆ There are up to 8 rating levels on a disc.
 - ◆ If LEVEL 6 is selected, a disc which contains rating LEVEL 7 and above cannot be played.
 - ◆ If you select **NEW PASSWORD**, the screen changes and enables you to enter the new password.

When the rating level password has been forgotten

While the player is in the stop mode, hold the Mono/ST button down on the main unit for more than 5 seconds.

- ◆ "INITIAL" appears on the display and all default settings will return to Factory Preset.
- ◆ Press the **On/Standby** (⏻/⏻) button.

System Setup (Cont'd)

GB

DIGITAL OUTPUT

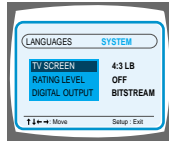

BITSTREAM Select this if Dolby Digital 5.1 CH connections have been made.

- ◆ Sends a digital signal that carries the Dolby Digital 5.1 or DTS multichannel information to your external decoder.

LPCM Select this otherwise.

- ◆ Sends a linear PCM(Pulse Code Modulation), or 2 channel stereo signal, to your A/V receiver.

Setting up the Language Features

Using the DVD player's Setup function, you can customize the Menu Language, Subtitle Language, and Disc Menu Language.

To set up the language feature

- 1 Press the **Setup** button from the stop mode.

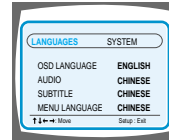

- 2 Press the **Up/Down** (▲/▼) button to select the desired item.

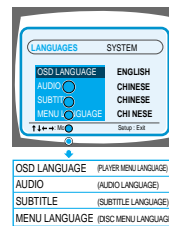

- 3 Press the **Enter** button or **Right** (▶) button.
 - ◆ Move to the language features.
 - ◆ Then press the **Left** (◀) button to return the previous step.

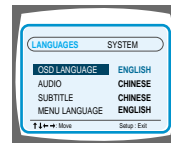

- 4 Press the **Up/Down** (▲/▼) button to select the desired language and then press the **Enter** button.

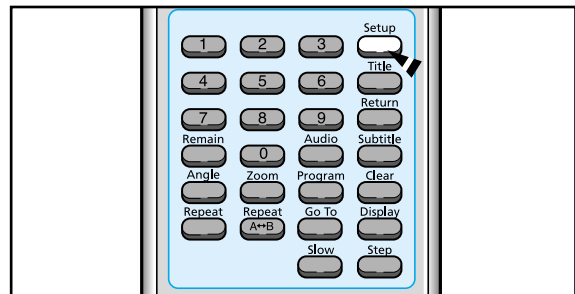

To End the Language Features Setup

- ◆ Press the **Setup** button again.

Searching for and Storing the Radio Stations

You can store up to:

- ◆ 15 FM stations (option)
- ◆ 15 AM stations
- ◆ 15 FM stations
- ◆ 8 MW stations (option)
- ◆ 7 LW stations
- ◆ 15 FM stations
- ◆ 5 MW stations
- ◆ 5 SW1 stations (option)
- ◆ 5 SW2 stations

- 1 Switch the system on by pressing **On/Standby** (⏻).
- 2 Select the required frequency band by pressing **TUNER/Band** again.
Result: The appropriate indication is displayed:

◆ FM	Frequency Modulation
◆ AM(MW)	Medium Wave
◆ LW(OPTION)	Long Wave
◆ SW1, SW2(OPTION)	Short Wave
- 3 To search for a station... Press Tuning Mode
 Manually One or more times until **MANUAL** is displayed.
 Tuning in to a until **"PRESET"** is displayed
Preset Station
 ➤ PRESET function is explained in detail in the section "Selecting a Stored Station" on.
- 4 Select the station to be stored by:
 - ◆ Pressing ◀ or ▶ buttons to increase or decrease the frequency respectively.
 - ◆ If performing automatic tuning, press and hold ◀ or ▶ button. **"AUTO"** is displayed and the search automatically stops at the frequency of a receivable station.
 - ◆ The automatic search procedure may stop on a frequency that does not correspond to a radio station. If this happens, use the manual search mode.
- 5 If you do not want to store the radio station found, revert to Step 4 and search for another station.
 Otherwise:
 - a Press **Program**.
Result: **PROG** and the program number are displayed.
 - b Press ◀ or ▶ to assign a program number between 1 and 15.
 - c Press **Program** to store the radio station.
Result: **PROG** is no longer displayed and the station is stored.
- 6 To store any other radio frequencies required, repeat Steps 3 to 5.

➤ ◆ The PROGRAM function can be used to assign a new station to an existing program number.

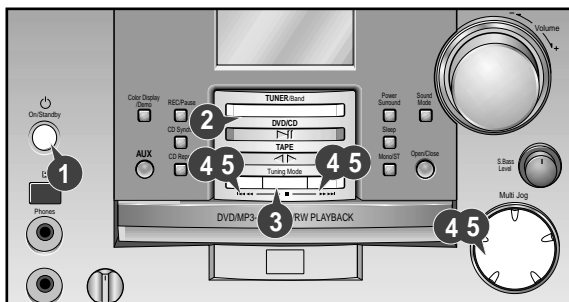

Selecting a Stored Station

You can listen to a stored radio station as follows:

- 1 Switch the system on by pressing **On/Standby** (⏻).
- 2 Select the required frequency band by pressing **TUNER/Band** on the front panel.
- 3 Select the radio station as follows.

To listen to ...	Press ...
Stored station	1. the Tuning Mode button until "PRESET" is displayed. 2. ◀ or ▶ button to select the required program.

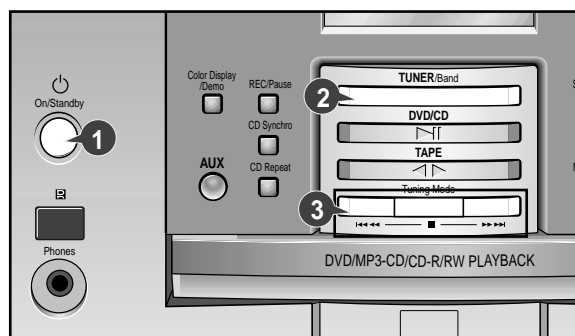

Improving Radio Reception

You can improve the quality of radio reception by:

- ◆ Rotating the FM or AM(MW) aerial
- If reception from a specific FM radio station is poor, press **Mono/ST** to switch from stereo mode to mono. The quality of the sound will be improved.

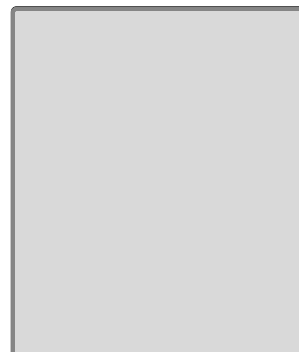

Listening to a Cassette



- Always treat your cassettes with care; refer, if necessary, to the section entitled "Precautions When Using Audio Cassettes" on page 30.

- 1 Switch the system on by pressing **On/Standby** (⏻).
- 2 Open the cassette deck by pushing on the corner of the cover marked **Push Eject** (▲) until you hear a click and then releasing it.
 - ◆ Insert the pre-recorded cassette with the open edge of the tape facing downwards.

- 3 Close the deck by pushing on it until it clicks into place.

- 4

To listen to...	Press ...
Side A	Tape (◀▶) button once.
Side B	Tape (◀▶) button twice.

Result: The cassette starts playing.

- 5 Press the ◀▶, ▶▶ button if necessary.

- | To... | Press ... |
|---------------------------|------------|
| Rewind the cassette | ◀ button. |
| Fast-forward the cassette | ▶▶ button. |

- 6 When you have finished playback, press ■ button.

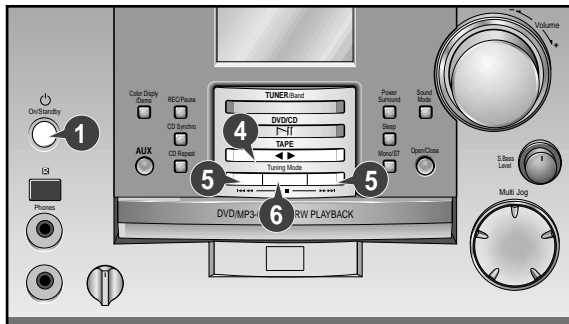

Tape Counter

When playing a cassette in one of the cassette decks, a counter is displayed to enable you to take note of the counter value at the start of each track to start playback at the beginning of the track to which you wish to listen.

- Before starting to record a cassette for which you wish to take note of the counter values at the beginning of each track, reset the counter by pressing Counter Reset on the front panel.

- Each cassette deck has a separate counter.

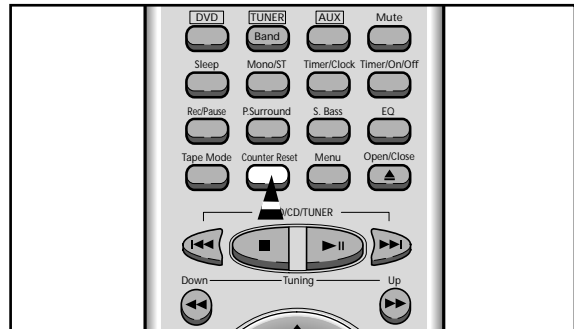

Selecting the Cassette Playback Mode

Your micro component system has three cassette playback modes which enable you to listen to both sides of a cassette automatically. Press Tape Mode until the appropriate symbol is displayed.

When the display indicates... The micro component system plays back...

- ▶▶ One side of the selected cassette and then stops.
- ◀▶ One side of the cassette. The other side of the cassette and then stops.
- ⌛ Both sides of the cassette indefinitely until you press stop.

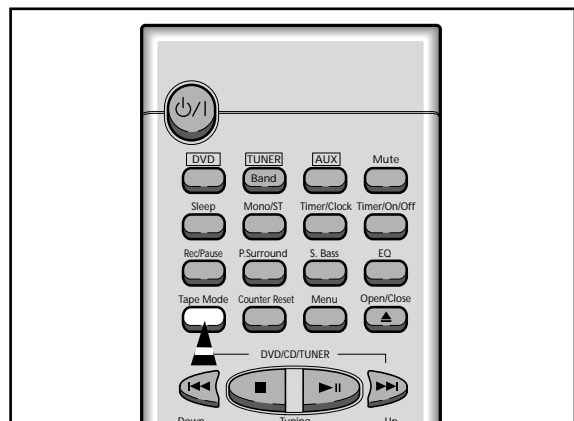

Recording a Compact Disc

You can record a compact disc on a cassette in two different ways:

- ◆ Synchronised recording
- ◆ Direct recording

➤ If the REC button is pressed while playing back a 5.1 channel encoded DVD, no sound will be output from the center and rear speakers.

Synchronised recording

This feature enables you to synchronize the start of the recording with the start of the disc or track of your choice.

- 1 Switch the system on by pressing **On/Standby** (⏻).
- 2 Insert a blank cassette in Deck.
- 3 Load a compact disc.
- 4 Press the **DVD/CD** (▶||) button.
 - ◆ Use the CD selection (◀◀, ▶▶) buttons to select the desired song.
- 5 Press the **CD Synchro** button on the remote control.
 - ◆ When stopped, press the button to start the recording from the first piece of music.
 - ◆ Press CD Synchro button on the remote control during the playback of CD to start the recording from the first part of the music being played.
- 6 To stop recording, press ■ button.

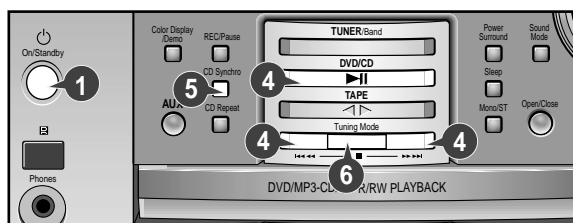

Direct recording

The direct recording mode enables you to start recording with any track on the compact disc.

- ◆ You do not need to adjust the volume, as it has no effect on the recording.

- 1 Switch your system on by pressing **On/Standby** (⏻).
- 2 Insert a blank cassette in Deck.
- 3 Load a compact disc.
- 4 Press the **DVD/CD** (▶||) button.
 - ◆ Use the CD selection (◀◀, ▶▶) buttons to select the desired song.
- 5 Press the **REC/Pause** button.

Result: Recording will begin.
- 6 To stop recording, press ■ button.

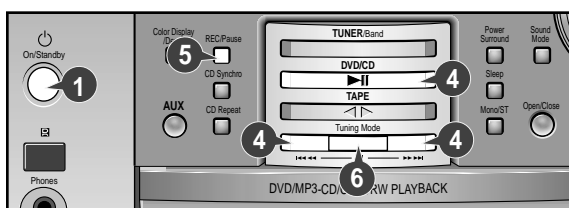

Recording a Radio Program

You can record a radio program of your choice.

- ◆ You do not need to adjust the volume, as it has no effect on the recording.

- 1 Switch the system on by pressing **On/Standby** (⏻).
- 2 Insert a blank cassette in Deck.
- 3 Select the **TUNER** function by pressing **TUNER/Band**.
- 4 Select the radio station that you wish to record by pressing ◀◀ or ▶▶ button.
- 5 Press **REC/Pause**.

Result: REC is displayed in red and recording starts.
- 6 To stop recording, press ■ button.

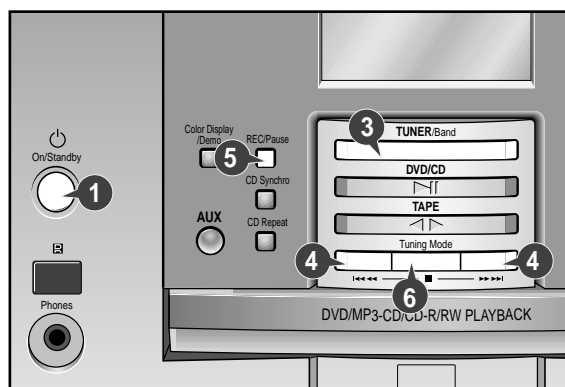

GB



Timer Function



The timer enables you to switch the system on or off at specific times.

Example: You wish to wake up to music every morning.

- If you no longer want the system to be switched on or off automatically, you must cancel the timer.
- ◆ Before setting the timer, check that the current time is correct.
- ◆ For each step, you have a few seconds to set the required options. If you exceed this time, you must start again.

- 1 Switch the system on by pressing **On/Standby** (⏻).
- 2 Press **Timer/Clock** until ⌚ **TIMER** is displayed.
- 3 Press **Enter**.
Result: **ON TIME** is displayed (instead of the equalizer symbols) for a few seconds, followed by any switch-on time already set; you can set the timer switch-on time.
- 4 Set the timer switch-on time.
 - a Set the hour by pressing ◀ or ▶ button.
 - b Press **Enter**.
Result: The minutes flash.
 - c Set the minutes by pressing ◀ or ▶ button.
 - d Press **Enter**.
Result: **OFF TIME** is displayed (instead of the equalizer symbols) for a few seconds, followed by any switch-off time already set; you can now set the timer switch-off time.
- 5 Set the timer switch-off time.
 - a Set the hour by pressing ◀ or ▶ button.
 - b Press **Enter**.
Result: The minutes flash.
 - c Set the minutes by pressing ◀ or ▶ button.
 - d Press **Enter**.
Result: **VOL 10** is displayed, where **10** corresponds to the volume already set.
- 6 Press ◀ or ▶ button to adjust the volume level and press **Enter**.
Result: The source to be selected is displayed.
- 7 Press ◀ or ▶ button to select the source to be played when the system switches on.

If you select...	You must also...
TAPE (cassette)	Insert a cassette tape.
TUNER (radio)	a Press Enter . b Select a preset station by pressing Tuning ◀ or ▶.
CD (compact disc)	Load a compact disc.

- 8 Press **Enter** to confirm the timer.
- 9 Press **On/Stanby** (⏻) to set the system to standby mode.
Result: ⌚ is displayed to the bottom right of the time, indicating that the timer has been set. The system will switch on and off automatically at the required times.

- ◆ If the timer switch on and off times are identical, the word **ERROR** is displayed.
- ◆ You can also use **Multi Jog** to instead ◀ or ▶ button in step 4, 5, 6, 7.

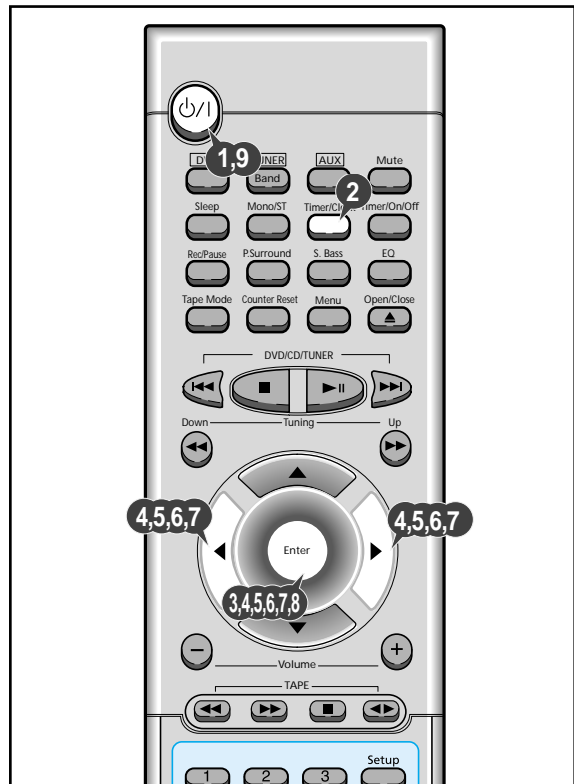

Canceling the Timer

After having set the timer, it will start automatically as shown by the **TIMER** indication on the display. If you no longer wish to use the timer, you must cancel it.

- You can stop the timer at any time (system on or in standby mode).

To...	Press Timer On/Off...
Cancel the timer	Once. Result: ⌚ is no longer displayed.
Restart the timer	Twice. Result: ⌚ is displayed again.

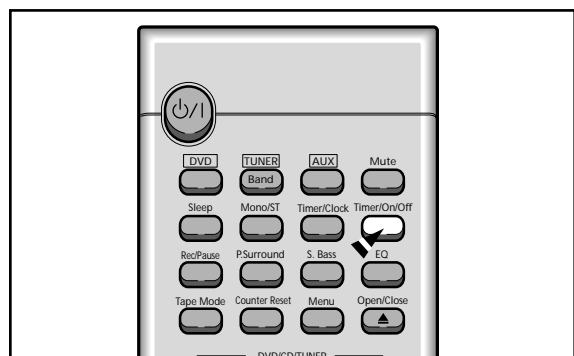

Mute Function

You can turn the sound off temporarily on your system.
Example: You wish to answer a telephone call.

- 1 Press **Mute**.
- 2 To switch the sound back on (at the same volume as before), press **Mute** again or the **Volume** buttons.



S. Bass Function



S.Bass function emphasizes the bass sound to produce the effect of explosion or booms.

Turn the **S.Bass Level** knob.

- ◆ Turn the knob clockwise or counterclockwise to switch between OFF ↔ S.BASS 1 ↔ S.BASS 2 ↔ S.BASS 3.
- ◆ Select the desired level for the bass.
- ◆ To operate from the remote control unit, press **S.Bass** button to select the desired mode.

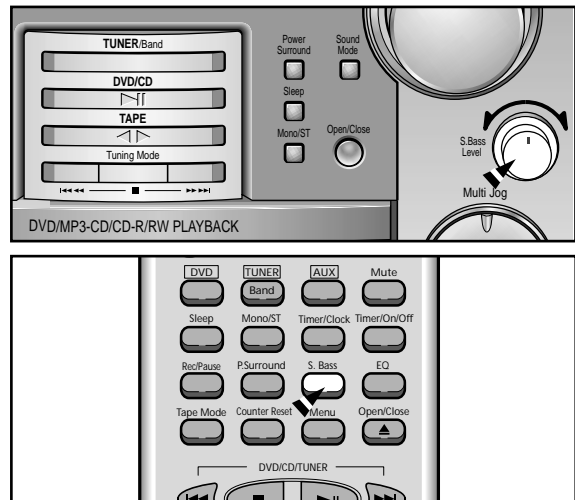

Selecting an Equalizer Preset

Your micro component system is equipped with a preset equalizer that allows you to choose the most appropriate balance between treble and bass frequencies, according to the type of music you are listening to. The function of Power Sound amplifies bass and improves high key or bass twice as much for you to appreciate powerful real sound.

Press **Sound Mode** on the front panel until the required option is selected.

- Press the button repeatedly to select **"PASS → POP → ROCK → CLASSIC"**.

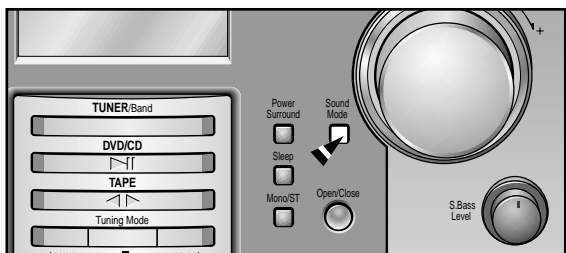

Power Surround

This machine is equipped with the function of Power Sound which amplifies bass treble output to twice as much for powerful real sound.

- 1 Press the **Power Surround** button.
 - ◆ Press the button repeatedly to select "P. SURR → OFF".
- 2 To cancel this function, press **Power Surround** button again.

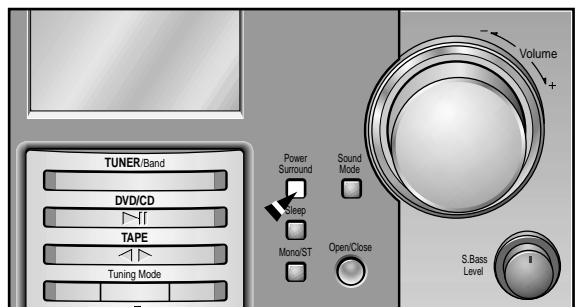

- When playing a 5.1 channel encoded DVD, the EQ, S.Bass, and Power Surround functions cannot be selected because the original sound is reproduced.

Setting the System to Switch off Automatically

GB

While listening to a compact disc or a cassette, you can set the system to switch off automatically

Example: You wish to go to sleep to music.

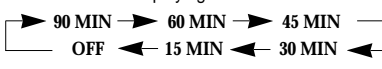
- 1 Press **Sleep**.
Result: The following indications are displayed:
90 MIN
- 2 Press **Sleep** one or more times to indicate how long the system should continue playing before it switches off:

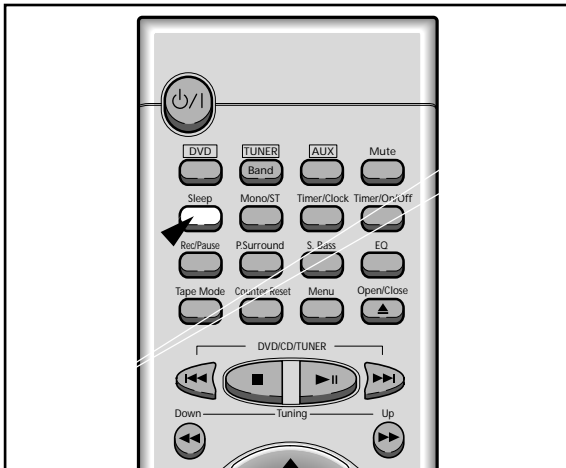
 - At any time, you can:
 - ◆ Check the remaining time by pressing **Sleep**
 - ◆ Change the remaining time by repeating Steps 1 and 2
- 3 To cancel SLEEP function, press **Sleep** one or more times until **OFF** is display.



Connecting Headphones

You can connect a set of headphones to your micro component system so that you can listen to music or radio programs without disturbing other people in the room. The earphones must have a 3.5mm jack or an appropriate adapter.

Connect the headphones to the **Phones** jack on the front panel.
Result: The loudspeakers are no longer used to output the sound.

- ⚠ Prolonged use of headphones at a high volume may damage your hearing.

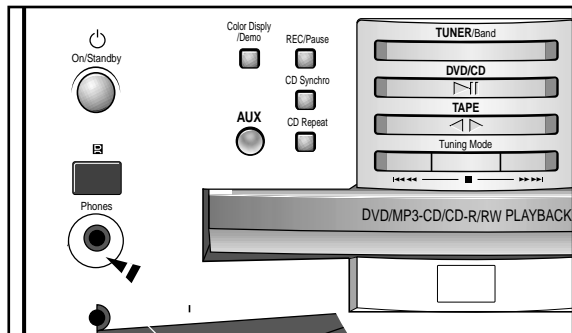

Microphone Function (option)

The microphone enables the user to mix in his or her vocals to sing-along with the music.

Preparation
Plug the microphone with a 3.5mm mic jack into microphone terminal. Turn the MIC Mixing knob to adjust the MIC volume.

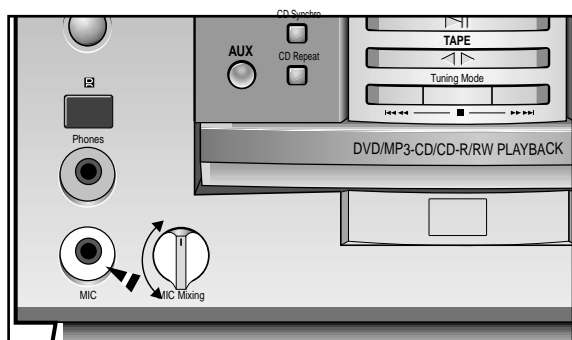

Safety Precautions

The following diagrams illustrate the precautions when using or moving your micro component

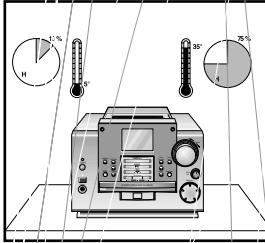

Ambient operating conditions:
Ambient temperature 5°C-35°C
Humidity 10-75%

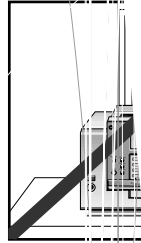

Do not expose the unit to radiation or other heat. This could lead to over-temperature and malfunction of the unit.

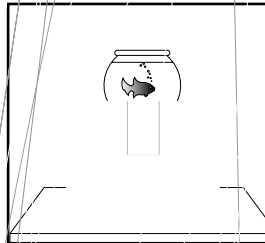

Do not place potted plants or vases on top of the unit. Moisture entering the unit could lead to dangerous electric shock and can cause equipment damage. In such events immediately disconnect the main plug from the socket.

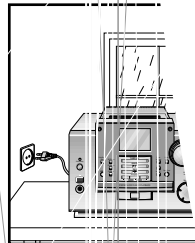

During thunderstorms, disconnect the main plug from the socket. Main voltage peaks due to lightning could damage the unit.

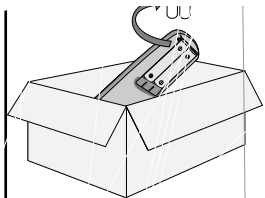

Remove the batteries from the remote control, if not used for any extended period. Leaking batteries can cause serious damage to the remote control.

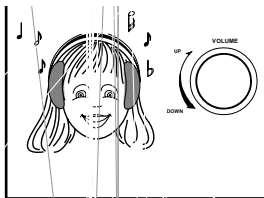

When using headphones, take care not to listen at excessive volumes. Extended use of headphones at high volumes will lead to hearing damage.

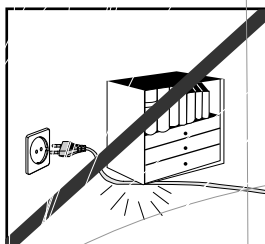

Do not place heavy items on the main lead. Main cable damage can lead to damage of the equipment (fire hazard) and can cause electric shock.

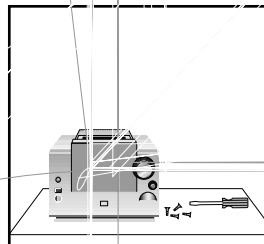

Do not remove any equipment panels. The inside of the unit contains live components, which can cause electric shock.

Cleaning Your System

To obtain the best possible performance from your micro component system, you must clean it regularly.

- ◆ The outer casing
- ◆ The compact disc player
- ◆ The cassette players (including the tape deck)
- ◆ Always unplug the unit before cleaning
- ◆ If you are not going to use the unit for a long time, clean it before you store it.

Outer Casing

Clean the outer casing regularly. Do not use abrasive powders, liquid detergents or solvents. Never let any liquids get into the system.

Compact Disc Player

Before playing a disc, clean the disc with a soft, lint-free cloth. Do not use the same cloth for cleaning vinyl LP records. Carefully wipe the disc from the center to the outer edge.

Regularly clean the player with a soft, lint-free cloth. For more information, contact your local dealer.

Headphones

Press **Push Eject** (▲) to eject the disc.

Use a cotton bud and a spray cleaner to clean the headphones.

- ◆ Head (1)
- ◆ Rollers (2)
- ◆ Drive capstans (3)

Component Maintenance

GB

To maintain your micro component system, you must clean it regularly.

Clean the drive capstans (3) and the tape deck (4) with a lint-free cloth. Do not use any solvents or abrasive powders.

Do not use the unit for a long time.

Use a soft, lint-free cloth and a light detergent. Do not use any solvents or abrasive powders. Never let any liquids get into the system.

Use a soft, lint-free cloth to clean the disc. Do not use any solvents or abrasive powders.

Use a soft, lint-free cloth to clean the disc. Do not use any solvents or abrasive powders.

Use a soft, lint-free cloth to clean the disc. Do not use any solvents or abrasive powders.

Use a soft, lint-free cloth to clean the disc. Do not use any solvents or abrasive powders.

- ◆ If you will not be using the unit for a long time, remove the batteries from the remote control.
- ◆ Although your system is designed to be used in an excessive environment or subjected to direct sunlight, etc., avoid using the unit in such environments.
- ◆ If the unit emits an unusual odor when in use, unplug it from the main supply and contact the after-sales service.

Use a soft, lint-free cloth to clean the disc. Do not use any solvents or abrasive powders.

Use a soft, lint-free cloth to clean the disc. Do not use any solvents or abrasive powders.

Use a soft, lint-free cloth to clean the disc. Do not use any solvents or abrasive powders.

Precautions When Using Compact Discs

GB

- ◆ Handle your compact discs with care. Always hold them by the edges to avoid leaving fingerprints on the shiny surface.
- ◆ When you have finished playing a compact disc, always put it back in its case.
- ◆ Do not fix paper or adhesive tape to the discs and do not write on the label.
- ◆ Clean them with a special-purpose cloth.
- ◆ Store your compact discs in a clean place, out of direct sunlight, where they will not be exposed to high temperatures.
- ◆ Always use compact discs marked .

Precautions When Using Audio Cassettes

- ◆ Check that the tape in the cassette is sufficiently taut.
- ◆ To prevent erasing a cassette that you wish to keep, remove the safety tab on the upper edge of the cassette. To record a cassette, where the tab has been broken, simply cover the opening with adhesive tape.
- ◆ When you have finished playing a cassette, always put it back in its case.
- ◆ Store your cassettes in a clean place, out of direct sunlight, where they will not be exposed to high temperatures.
- ◆ Avoid using 120-minute cassettes as they place unnecessary strain on the tape mechanism.

Before Contacting the After-Sales Service

It always takes a little time to become familiar with a new appliance. If you have any of the problems listed below, try the solutions given. They may save you the time and inconvenience of an unnecessary service call.

Problem	Checks/Explanation
The system does not work	<ul style="list-style-type: none"> • The main lead is not correctly plugged into a wall socket or the wall socket is not switched on. • The remote control batteries need replacing or the polarity has not been respected. • The On/Standby button has not been pressed.
G E N E R A L There is no sound	<ul style="list-style-type: none"> • The volume has been completely turned down. • The correct function (TUNER, CD, TAPE, AUX) has not been selected. • You have connected a set of earphones. • The loudspeaker wires have been disconnected. • The Mute button has been pressed.
The Timer does not work	<ul style="list-style-type: none"> • The timer has been stopped by pressing Timer On/Off.
In case it does not work, even the action is taken as above.	<ul style="list-style-type: none"> • Press the Sound Mode button for 5 seconds in power 'OFF'(standby), then it is returned the original position (RESET)
The compact disc player does not start playing	<ul style="list-style-type: none"> • The CD function has not been selected. • The disc has been inserted face down or is either dirty or scratched. • The laser sensor is dirty or dusty. • The system has not been installed on a flat, horizontal surface. • Condensation has formed in the player; leave the system in a warm, airy room for at least one hour.
C D / D V D When playing a DTS, DVD disc, no sound is produced.	<ul style="list-style-type: none"> • Since this product incorporates technology, no sound will be output directly from the main unit. • To listen to DTS sound, connect an amplifier equipped with a DTS decoder to the digital output (OPTICAL OUT).
C A S S E T T E S The tape does not start playing	<ul style="list-style-type: none"> • The TAPE function has not been selected. • The cassette has not been inserted correctly. • The cassette player has not been closed. • The tape is either slack or broken.
The volume falls off	<ul style="list-style-type: none"> • The audio heads are dirty.
The cassette is not erased correctly	<ul style="list-style-type: none"> • The rollers or drive capstans are dirty.
There is excessive wow and flutter	<ul style="list-style-type: none"> • The tape is worn.
R A D I O Reception is poor or no radio stations are received at all	<ul style="list-style-type: none"> • The TUNER function has not been selected. • The radio frequency has not been correctly selected. • The aerial has been disconnected or is not facing the right way. Turn it until you find the best orientation. • You are in a building that blocks radio waves; you must use an outside aerial.

If the above guidelines do not allow you to solve the problem, take a note of:

- ◆ The model and serial numbers, normally printed on the rear of the system
- ◆ Your warranty details
- ◆ A clear description of the problem

Then contact your local dealer or SAMSUNG after-sales service.

Technical Specifications



SAMSUNG strives to improve its products at all times. Both the design specifications and these user instructions are thus subject to change without notice.

RADIO

LW(option)

Usable sensitivity 60 dB

SW(option)

Usable sensitivity 40 dB

AM (MW)

Signal/noise ratio 40 dB

Usable sensitivity 54 dB

Total harmonic distortion 2 %

FM

Signal/noise ratio 62 dB

Usable sensitivity 3 dB

Total harmonic distortion 1.0 %

COMPACT DISC PLAYER

Frequency range 20 Hz - 20 KHz (± 1 dB)

Signal/noise ratio 80 dB (at 1 KHz) with filter

Distortion 0.05 % (at 1 KHz)

Channel separation 70 dB

Disc sizes Diameter: 120 or 80 mm. Thickness: 1.2 mm

TAPE DECK

Frequency range 125 Hz ~ 10 KHz

Signal/noise ratio 40 dB

Channel separation 35 dB

Erasing effect 60 dB

AMPLIFIER

Output power

◆ Main(6 Ω)2 X 12 Watts RMS (total harmonic distortion : 10%)

◆ Center(6 Ω)12 Watts RMS (total harmonic distortion : 10%)

◆ Rear(6 Ω)2 X 12 Watts RMS (total harmonic distortion : 10%)

◆ Subwoofer(4 Ω)2 X 28 Watts RMS (total harmonic distortion : 10%)





Channel separation 45 dB

Signal/noise ratio 72 dB

GENERAL

Dimensions 240(W) x 177 (H) x 322(D) mm

Note on Terminology

ANGLE	Recorded onto some DVD discs are scenes which have been simultaneously shot from a number of different angles (the same scene is shot from the front, from the left, from the right, etc.). With such discs, the Angle button can be used to change the angle of view for specific scenes.
CHAPTER NUMBER	These numbers are recorded on DVD discs. A Title is subdivided into many sections, each of which is numbered, and specific parts of the video can be searched quickly using these numbers.
DVD	A high-density optical disc on which high-quality pictures and sound have been recorded by means of digital signals. Incorporating a new video compression technology (MPEG-2) and high-density recording technology, a DVD disc comprises two 0.6 mm thick discs bonded together.
PCM	An acronym for Pulse Code Modulation - another name for digital audio.
PBC (PLAYBACK CONTROL)	This is recorded on a video CD (version 2.0). Selected scenes or information can be chosen from the menu displayed on the TV monitor.
REGION NUMBER	Both the DVD player and DVD discs are encoded with a region number. If the region number on the DVD disc does not correspond to the region number of the DVD player, the player cannot play the disc.
SUBTITLES	Translated appearing at the bottom of the screen. A DVD disc can contain up to 32 subtitle languages.
TITLE NUMBER	These numbers are recorded on DVD discs. When a disc contains two or more movies, these movies are numbered as Title 1, Title 2, etc.
TRACK NUMBER	These numbers are assigned to the tracks which are recorded on video and audio CDs. They enable specific tracks to be located quickly.
VIDEO CD	Contains recordings of pictures and sound whose quality is roughly comparable to that of video tape. This player also supports video CDs with playback control (version 2.0).
	You can enjoy 5.1 (or 6) channels of high fidelity digital sound from various digital input sources such as laser discs, DVD, CD etc. DTS provides a realistic, clear surround sound that has not previously been available from conventional surround sound.
	5.1 (or 6) Channel Digital Surround sound reproduced from DVDs and LDs recorded as a digital signals (with  disc marking). With better sound quality, dynamic range, and directionality than the traditional Dolby surround technology, you can enjoy the dynamic realistic sound.
	A 4 channel analog sound reproduced from a program source such as a video-tape or LD with the  mark. You can enjoy a more realistic, robust sound unavailable from regular stereo sources.

THIS APPLIANCE IS MANUFACTURED BY:



AH68-01102J